

Select Objects Individually

You can select one or more objects individually at the Select Objects prompt.

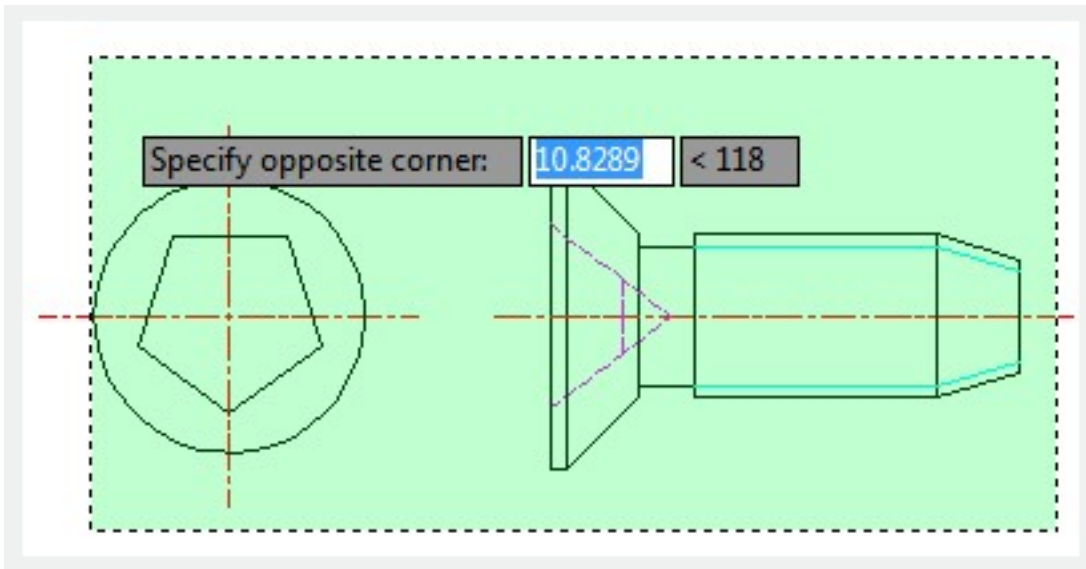

Use the Pick box Cursor

Move the pick box cursor over an object and click, you can select objects. If selection preview is turned on, when you move the pick box cursor in position to select an object, the object will be highlighted. In the Options dialog box, Selection tab, you can modify the size of the pick box.

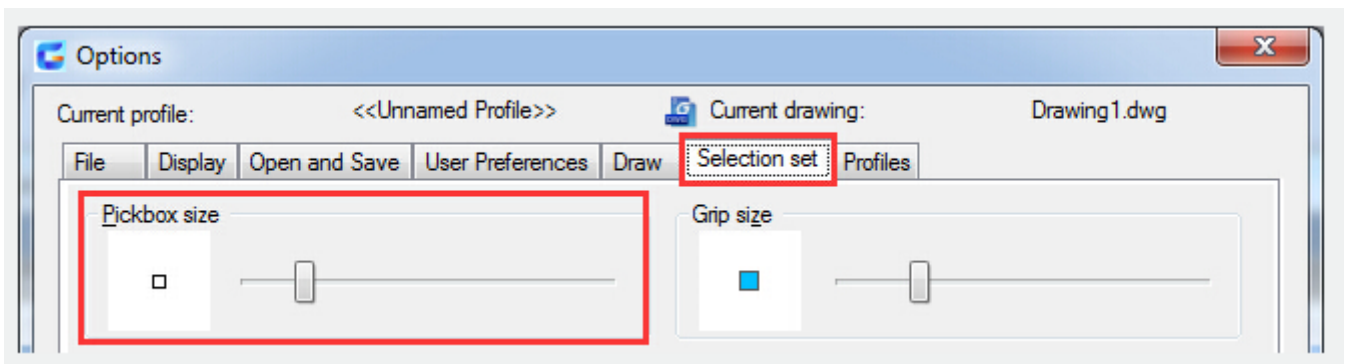

Remove Selection from Objects

Hold down SHIFT and select the object again to remove it from the current selection set.

Prevent Objects from Being Selected

You can lock a layer, if you want to avoid that objects on that layers are selected and modified. While editing of certain objects is impossible on locked layers, you can still perform other operations like making a locked layer current or adding objects to it.

Online URL: <https://www.kb2.gstarcad.com.my/article.php?id=2541>