

DIMORDINATE command

2087 GstarCAD MY /KW August 11, 2021 [CAD Commands](#) 0 1959

The **DIMORDINATE** command is used to create ordinate dimensions.

Command Access:

Ribbon : Annotation > Dimension > Dimension > Ordinate

Menu : Dimension > Ordinate

Command : DIMORDINATE

Command Prompts:

Specify feature location:

Specify leader endpoint or [Xdatum/Ydatum/Mtext/Text/Angle]:

Function Description:

The ordinate dimension measures the horizontal or vertical distance from base point to specified point.

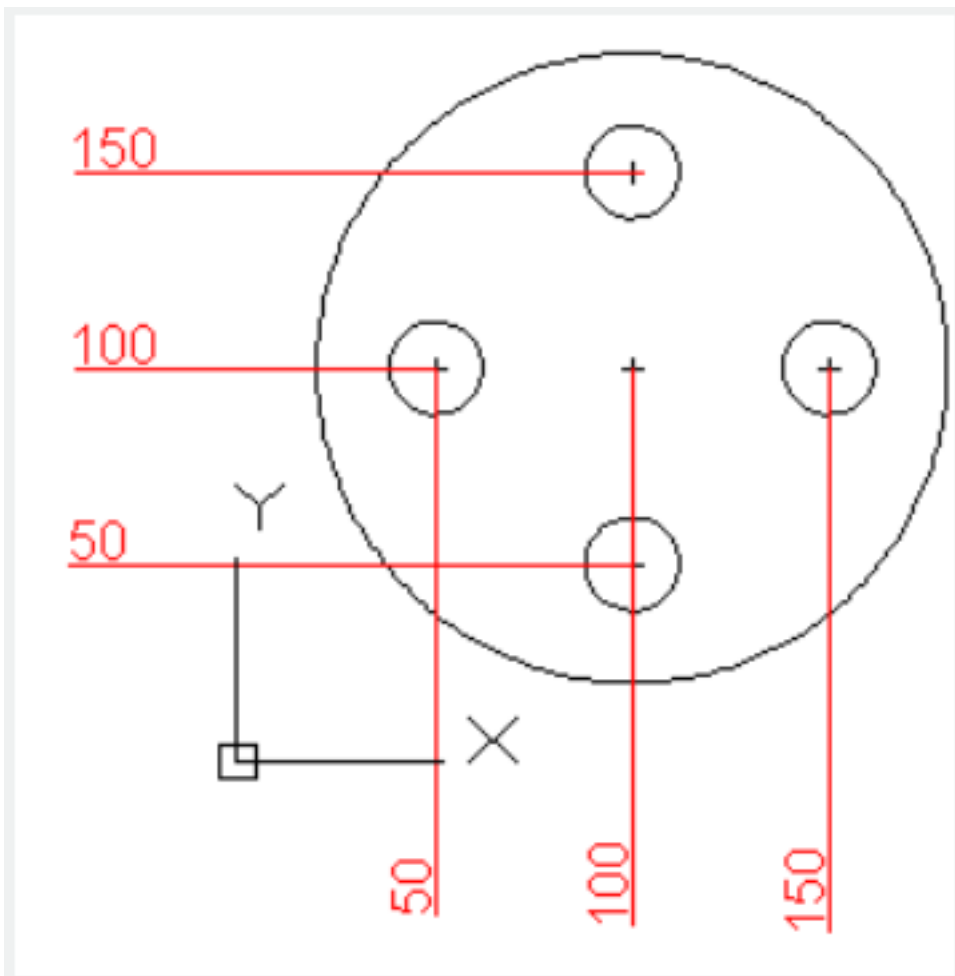

Relative Glossary:

Leader endpoint:

When selected feature location and leader point, the difference in X datum and Y datum determine the displaying dimension. If the difference of X coordinate is greater than Y coordinate, the dimension displays Y coordinate of specified point; otherwise displays X coordinate.

X datum:

Measuring X coordinate of specify point and specify the direction of leader line and dimension text. Users could specify the leader endpoint under the prompt.

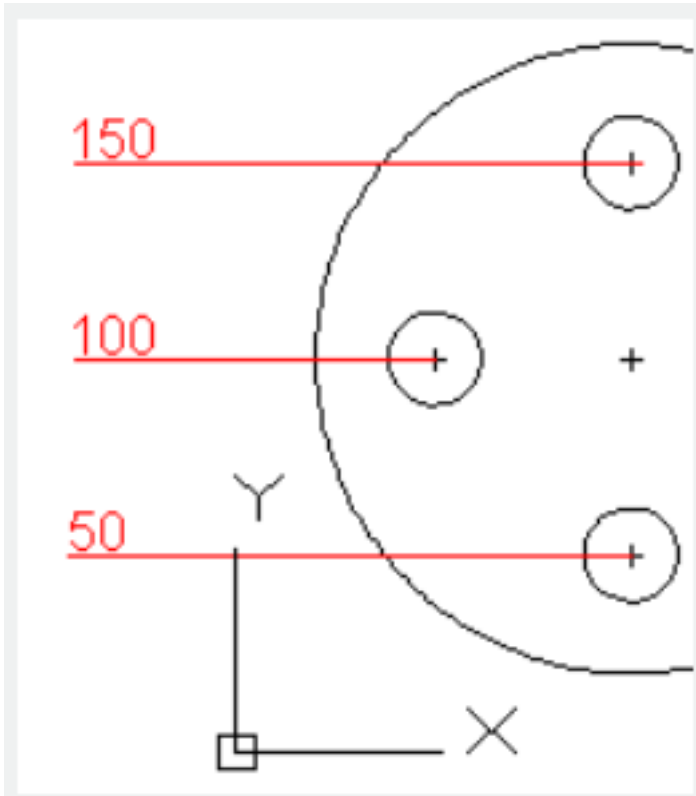

Mtext:

Edit dimension text by In-place text editor. Users could input special characters and symbols by control code or Unicode character string.

If the unit conversion is off, users could input square bracket ([]) to display them.

The current dimension style determines the appearance of generated measured value.

Text:

Customize dimension text under command prompt.

The generated measured value will be displayed in angle bracket (<>). If the unit conversion is off, users could input square bracket ([]) to display them.

User could reset the dimension style in "Text" option of New, Modify, and Override in Dimension Style Manager Dialog box.

Angle:

Modify angle of text.

